



Elvaco Sense

Wireless M-Bus Indoor Sensors
100W, 200W, 300W

User's Manual

English
v1.0

Contents

1	DOCUMENT NOTES	4
1.1	COPYRIGHT AND TRADEMARK	4
1.2	CONTACTS.....	4
2	IMPORTANT USAGE AND SAFETY INFORMATION	5
3	USING THIS MANUAL	6
3.1	PURPOSE AND AUDIENCE	6
3.2	ONLINE RESOURCES	6
3.3	SYMBOLS.....	6
4	INTRODUCTION.....	7
4.1	PURPOSE.....	7
4.2	APPLICATION DESCRIPTION.....	7
4.3	PRODUCT FEATURES.....	7
4.4	COMPATIBILITY.....	8
5	GETTING STARTED.....	9
5.1	PURPOSE.....	9
5.2	PRODUCT SPECIFICATION	9
5.3	MOUNT THE DEVICE.....	9
5.3.1	<i>Mounting.....</i>	<i>9</i>
5.4	OPERATION.....	11
5.4.1	<i>Configuration using the OTC App</i>	<i>11</i>
5.4.2	<i>Configuration settings.....</i>	<i>11</i>
5.4.2.1	<i>LED flash</i>	<i>11</i>
5.4.3	<i>Transmit interval.....</i>	<i>11</i>
5.4.4	<i>Wireless M-Bus mode</i>	<i>12</i>
5.4.5	<i>Encryption mode</i>	<i>12</i>
5.4.6	<i>Configuration lock.....</i>	<i>12</i>
5.4.7	<i>CO₂ Calibration</i>	<i>12</i>
6	PROTOCOL SPECIFICATION.....	13
6.1	PURPOSE.....	13
6.2	M-BUS PRODUCT IDENTIFICATION	13
6.3	WIRELESS M-BUS MODE	13
6.4	ENCRYPTION MODE	13
6.5	TRANSMISSIONS.....	13
6.5.1	<i>Telegram description of Elvaco Sense 100W</i>	<i>13</i>
6.5.2	<i>Telegram description of Elvaco Sense 200W</i>	<i>14</i>
6.5.3	<i>Telegram description of Elvaco Sense 300W</i>	<i>15</i>
7	TROUBLESHOOTING	17
7.1	THE WIRELESS M-BUS RECEIVER DOES NOT RECEIVE ANY TELEGRAM FROM THE SENSOR 17	17
7.2	TEMPERATURE VALUE IS INACCURATE	17
8	TECHNICAL SPECIFICATIONS.....	18
8.1	CHARACTERISTICS	18
8.2	FACTORY DEFAULT SETTINGS	19

8.3	DIMENSIONS (MM)	19
9	TYPE APPROVALS.....	20
10	DOCUMENT HISTORY	21
10.1	VERSIONS.....	21

1 Document notes

All information in this manual, including product data, diagrams, charts, etc. represents information on products at the time of publication, and is subject to change without prior notice due to product improvements or other reasons. Latest product information can be downloaded from Elvaco AB public web site.

The documentation and product are provided on an “as is” basis only and may contain deficiencies or inadequacies. Elvaco AB takes no responsibility for damages, liabilities, or other losses (direct or indirect) by using this product.

1.1 Copyright and trademark

© 2023, Elvaco AB. All rights reserved. No part of the contents of this manual may be transmitted or reproduced in any form by any means without the written permission of Elvaco AB. Printed in Sweden.

The Elvaco Sense is a trademark of Elvaco AB, Sweden.

1.2 Contacts

Elvaco AB Headquarter
Kabelgatan 2T
434 37 Kungsbacka
SWEDEN
Phone: +46 300 30250
E-Mail: info@elvaco.com

Elvaco AB Technical Support
Phone: +46 300 434300
E-Mail: support@elvaco.se

Online: <http://www.elvaco.com>

2 Important usage and safety information

The following safety precautions must be observed during all phases of the operation, usage, service or repair of any Elvaco Sense product. Users of the product are advised to convey the information to users and operating personnel and, to incorporate these guidelines into all manuals supplied with the product. Failure to comply with these precautions violates safety standards of the design, manufacture and intended use of the product. Elvaco AB assumes no liability for customer's failure to comply with these precautions.

The installation of Elvaco Sense product should not be started before the information in this manual is completely understood. The installation must follow applicable regional regulations and be performed by qualified personnel.

To use the product's NFC functionality, follow the instructions issued by the manufacturer of the NFC reader for safe and efficient operation.

The labelling of the product should not be changed, removed or made unrecognizable.

3 Using this manual

3.1 Purpose and audience

This manual provides all information needed to mount, configure and use the Elvaco Sense 100W-300W Wireless M-Bus Sensors. The manual is intended for field engineers and integrators.

3.2 Online resources

To download the latest version of this user's manual, or to find information in other languages, please visit <http://www.elvaco.com/>.

3.3 Symbols

The following symbols are used throughout the manual to emphasize important information and useful tips:



The Note symbol is used to mark information that is important to take into consideration for safety reasons or to assure correct operation of the product.



The Tip symbol is used to mark information intended to help you get the most out of your product. It can for example be used to highlight a possible customization option related to the current section.

Table 1 provides information on how the product should be installed and recycled.



Symbol	Description
	Waste electrical products should not be disposed of with household waste. Please recycle where facilities exist. Contact your Local Authority for recycling advise.
	Electrostatic-sensitive device. Please observe the necessary ESD protective measures when installing the product.

Table 1: Installation and recycling information

4 Introduction

4.1 Purpose

This chapter provides a general description of the Elvaco Sense sensors. In the next-coming sections you will learn more about possible applications for the product and how Elvaco Sense sensors can be combined with other products to build versatile solutions.

4.2 Application description

The Elvaco Sense is a smart wireless M-Bus sensor solution with the ability to precisely measure CO₂, temperature and humidity. It's equipped with replaceable batteries and made for indoor use. The Scandinavian minimalist design makes it suitable in homes, offices and public spaces.

The sensor automatically starts to transmit wireless M-Bus telegrams as soon as the replaceable batteries are installed. Using the Elvaco OTC smartphone app, the sensor can be commissioned to suite various wireless M-Bus installations following the OMS standard. The user has the ability to change different settings such as transmit interval, encryption mode and wireless m-bus mode. The Elvaco OTC app can also be used to verify that the sensor is operational before leaving the installation site.

Following figure shows an example of how the Elvaco Sense can be used in an Elvaco end-to-end solution.

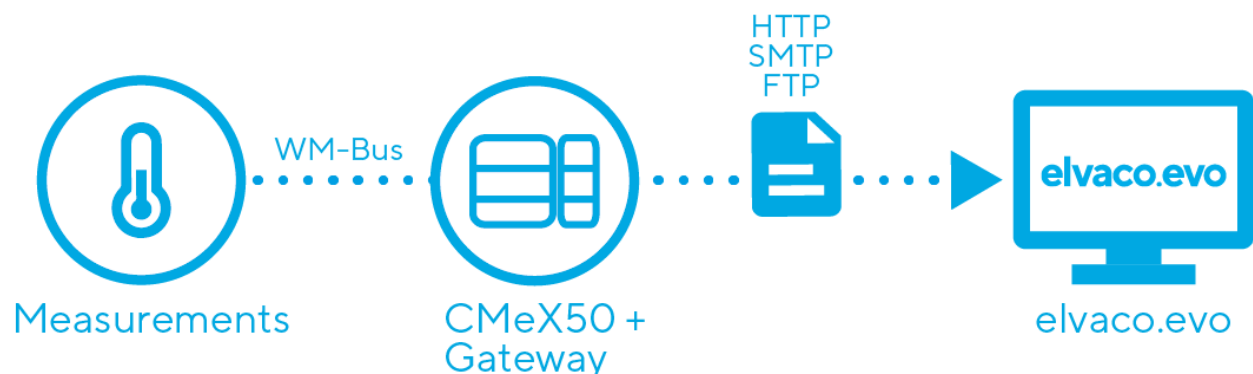

Figure 1 Application example

4.3 Product features

Key features of the Elvaco Sense series include:

- IoT-ready**
 As soon as the sensor has been mounted and started up, it will automatically initiate transmission of sensor data without any manual steps needed. The sensor is prepared for seamless integration with all wireless M-Bus receivers following the OMS standard.
- Long battery lifetime**
 The sensor is designed with replaceable batteries, which extends the product lifetime. The sensor is also designed to be energy efficient to enable up to 16 years of battery lifetime.
- Easy and fast commissioning**
 The Elvaco OTC app is used to configure and deploy sensors quickly and securely. Using the Elvaco OTC app, simply enter your desired settings and place your smartphone on the sensor.

New settings will be applied instantaneously using NFC.

- **High accuracy**

The sensors are equipped with the latest sensor technology giving best possible accuracy of its lifetime.

4.4 Compatibility

The Elvaco Sense series is OMS 4.0 compatible and can be used with any wireless M-Bus receiver following the OMS standard with the following configuration:

- Frequency 868.95 MHz
- Encryption mode 0 or 5
- Wireless M-Bus mode C1a, C1b or T1

5 Getting started

5.1 Purpose

This chapter provides instructions on how to get started with the Elvaco Sense sensors. After reading and carefully following each step of this chapter, your sensor will be installed and operational.

5.2 Product specification

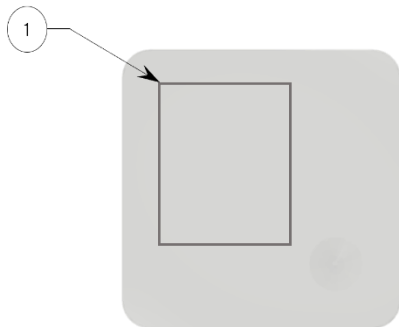

Figure 3: Elvaco Sense front

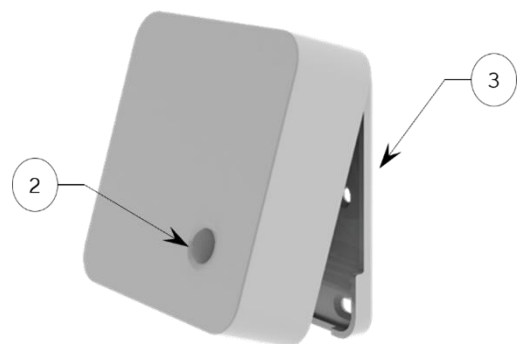

Figure 2: Elvaco Sense side

1. NFC antenna placement
2. LED
3. Serial number

5.3 Mount the device

5.3.1 Mounting

1. Remove the back panel of the sensor by gently prying the tab with a small screwdriver.



2. Install the 3.6V lithium battery/batteries (ER14505). Ensure that the plus and minus poles are facing the right direction. Upon installation the sensor will activate which is indicated by a long red flash followed by a long green flash.

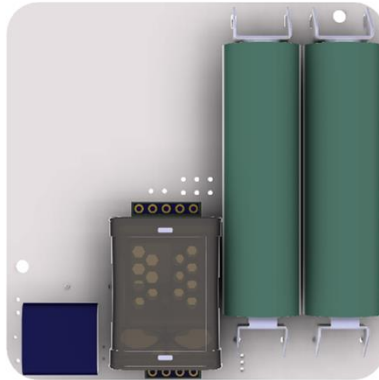

Caution: Using batteries other than the ones provided may result in loss of performance, battery life and damage to the device.

3. Use any of the four mounting holes to mount the back panel to the wall. At least two appropriate screws should be used. Alternatively attach the sensor with double sided adhesive tape.



Avoid mounting the product near supplementary heat sources, such as kitchen stoves or in direct sunlight.



Make sure to mount the product at least 1.5 meters above the floor and at least 1 meter from nearest radiator.



Do not mount the product on an external wall or near a door. If mounted over a conduit pipe, make sure that the pipe is filled to prevent air flow.



Do not mount the sensor in a steel cabinet. Doing so will dramatically decrease the signal coverage.

4. Attach the sensor part by hinging it on the back panel.



5.4 Operation

Upon installation of the batteries, the sensor will begin to transmit wireless M-Bus telegrams. The telegrams contain sensor data as well as various information about the product status. The Elvaco Sense are equipped with an NFC antenna, which can be used to configure settings or to read data using a smartphone. To read the current sensor values in the Elvaco OTC app, scan the sensor twice within 30 seconds. The first scan will wake up the sensor and collect the current sensor values.

5.4.1 Configuration using the OTC App

Download the Elvaco OTC app from Google Play or App Store to a smartphone. The smartphone must support NFC.



OTC app on Android



OTC app on iPhone

5.4.2 Configuration settings

For configuration settings on the Elvaco Sense, press SCAN in the OTC app and hold the smartphone on top of the NFC antenna of the sensor. Select APPLY in the OTC app and change the settings for a customized sensor experience.

5.4.2.1 LED flash

For successful configuration settings the LED will flash blue.

For Automatic Baseline Calibration On / Off the LED will begin to flash red and then continue to flash green.

For Fresh Air Calibration the LED will flash green.

5.4.3 Transmit interval

The transmit interval of the wireless M-Bus telegram can be set between one and fifteen minutes.

Note: Change of transmit interval will affect the battery lifetime.

5.4.4 Wireless M-Bus mode

Elvaco Sense has three different wireless M-Bus modes; C1a, C1b and T1.

5.4.5 Encryption mode

The Elvaco Sense wireless M-Bus telegram can be encrypted using mode 5 by selecting Yes in the line wM-Bus encryption enabled.

5.4.6 Configuration lock

The Elvaco Sense can be secured by disabling the possibility of applying configuration without having access to the Product Access Key (PAK). By enabling *setup lock* the sensor can only be configured or unlocked by a user having access to the PAK. Elvaco recommend enabling the *setup lock* during installation to secure the device for unwanted re-configuration.

To unable *setup lock* use the sensor key found in elvaco.evo portal. Upon delivery the customer will receive an invitation to the elvaco.evo portal via email, triggered by Elvaco.

5.4.7 CO₂ Calibration

Elvaco Sense has a self-correcting calibration algorithm, Automatic Baseline Calibration (ABC). The ABC uses the lowest sensor value over the last eight days and uses it as a baseline value corresponding to 400 ppm. For this to work correctly, the sensor must be exposed to well-ventilated air at least once every eight days. The ABC needs approximately one month to calibrate the sensor before being able to provide correct values.

The ABC is activated by default, and it can show incorrect values due to mechanical stress from transportation. Calibration can be done manually which will instantly calibrate the sensor. This process can be triggered using the Elvaco OTC app and placing the sensor in well-ventilated air for at least 10 minutes.

If the sensor is placed in a location where there are people constantly present, the recommendation is to turn the ABC calibration off and instead use the Elvaco OTC app and manually calibrate the sensor once a year.

6 Protocol specification

6.1 Purpose

This chapter contains the protocol specifications of the Elvaco Sense 100W, 200W and 300W. The wireless M-Bus implementation is according to M-Bus standards EN13757:2018

6.2 M-Bus product identification

The product can be identified using the following information:

- Manufacturer string = ELV
- Medium = 0x1B (Room sensor)

The M-Bus Generation field between product releases will only change (increase by one) if the M-Bus protocol information changes between sensor versions.

6.3 Wireless M-Bus mode

The product uses wireless M-Bus mode C1a (default), C1b or T1 which means that it sends spontaneous data in one direction, from sensor to wireless M-Bus receiver.

6.4 Encryption mode

The product supports both unencrypted and encryption mode 5. In encrypted mode, an AES 128-bit algorithm is used to encrypt all transmitted data from the sensor. In unencrypted mode, no data will be encrypted.

6.5 Transmissions

The product will automatically begin transmitting data after the batteries are inserted. By default, a SND_NR telegram will be transmitted according to the tables; *Table 2*, *Table 3*, *Table 4*.

6.5.1 Telegram description of Elvaco Sense 100W

Description of Elvaco Sense 100W – wM-Bus indoor temperature sensor

Byte index	Data	Description
0	0xnn	L-Field
1	0x44	C-Field: SND_NR
2..3	0x9615	Manufacturer "ELV"
4..7	0xnnnnnnnn	Identification number
8	0xnn	Version field: 80d..84d
9	0x1B	Device type (Medium) = Room sensor
10	0x7A	0x7A = short application header
11	0xnn	Access number, increases after each transmission (0...255)
12	0xnn	Status No Error: 0x00 Any Error: 0x10
13..14	0xnnnn	CONFIG: Bit 3..0 = 0 Bit 7..4 = 1 to 15, number of encrypted 16-byte block, 0 if

Byte index	Data	Description
		encryption = OFF Bit 12..8 = encryption mode, 5 with encryption, 0 without encryption Bit 13=1 (synchronized) Bit 15..14 = 0
15..16	0x2f2f	AES check (idle filler) Only if encrypted
17	0x02 (0x32 in case of error)	Instantaneous DIF
18	0xFD	VIF, extension table FD
19	0x46	VIFE, battery voltage in mV
20..21	0xnnnn	Instantaneous battery voltage In case of error this value will be set to 0.
22	0x02 (0x32 in case of error)	Instantaneous DIF
23	0x65	VIF, external temperature
24..25	0xnnnn	Instantaneous temperature x 100 In case of error this value will be set to 0.

Table 2: Telegram description of Elvaco Sense 100W

6.5.2 Telegram description of Elvaco Sense 200W

Description of Elvaco Sense 200W – wM-Bus indoor temperature and humidity sensor.

Byte index	Data	Description
0	0xnn	L-Field
1	0x44	C-Field: SND_NR
2..3	0x9615	Manufacturer "ELV"
4..7	0xnnnnnnnn	Identification number
8	0xnn	Version field: 85d..89d
9	0x1B	Device type (Medium) = Room sensor
10	0x7A	0x7A = short application header
11	0xnn	Access number, increases after each transmission (0...255)
12	0xnn	Status No Error: 0x00 Any Error: 0x10
13..14	0xnnnn	CONFIG: Bit 3..0 = 0 Bit 7..4 = 1 to 15, number of encrypted 16-byte block, 0 if encryption = OFF Bit 12..8 = encryption mode, 5 with encryption, 0 without encryption Bit 13=1 (synchronized) Bit 15..14 = 0
15..16	0x2f2f	AES check (idle filler) Only if encrypted
17	0x02 (0x32 in case of error)	Instantaneous DIF
18	0xFD	VIF, extension table FD
19	0x46	VIFE, battery voltage in mV

Byte index	Data	Description
20..21	0xn timer	Instantaneous battery voltage In case of error this value will be set to 0.
22	0x02 (0x32 in case of error)	Instantaneous DIF
23	0x65	VIF, external temperature
24..25	0xn timer	Instantaneous temperature x 100 In case of error this value will be set to 0.
26	0x02 (0x32 in case of error)	Instantaneous relative DIF
27	0xfb	VIF, extension table FB
28	0x1a	Instantaneous relative humidity VIFE
29..30	0xn timer	Instantaneous relative humidity x 10 In case of error this value will be set to 0.

Table 3: Telegram description of Elvaco Sense 200W

6.5.3 Telegram description of Elvaco Sense 300W

Description of Elvaco Sense 300W – wM-Bus indoor CO₂ multi sensor.

Byte index	Data	Description
0	0xnn	L-Field
1	0x44	C-Field: SND_NR
2..3	0x9615	Manufacturer "ELV"
4..7	0xn timer	Identification number
8	0xnn	Version field: 90d..94d
9	0x1B	Device type (Medium) = Room sensor
10	0x7A	0x7A = short application header
11	0xnn	Access number, increases after each transmission (0...255)
12	0xnn	Status No Error: 0x00 Any Error: 0x10
13..14	0xn timer	CONFIG: Bit 3..0 = 0 Bit 7..4 = 1 to 15, number of encrypted 16-byte block, 0 if encryption = OFF Bit 12..8 = encryption mode, 5 with encryption, 0 without encryption Bit 13=1 (synchronized) Bit 15..14 = 0
15..16	0x2f2f	AES check (idle filler) Only if encrypted
17	0x02 (0x32 in case of error)	Instantaneous DIF
18	0xFD	VIF, extension table FD
19	0x46	VIFE, battery voltage in mV
20..21	0xn timer	Instantaneous battery voltage In case of error this value will be set to 0.
22	0x02 (0x32 in case of error)	Instantaneous DIF
23	0x65	VIF, external temperature

Byte index	Data	Description
24..25	0xnxxx	Instantaneous temperature x 100 In case of error this value will be set to 0.
26	0x02 (0x32 in case of error)	Instantaneous relative DIF
27	0xfb	VIF, extension table FB
28	0x1a	Instantaneous relative humidity VIFE
29..30	0xnxxx	Instantaneous relative humidity x 10 In case of error this value will be set to 0.
31	0x02 (0x32 in case of error)	Instantaneous value, 16-bit DIF
32	0x7C	Plain-text VIF
33	0x03	Length of plain-text VIF
34	0x32	'2'
35	0x4F	'O'
36	0x43	'C'
37..38	0xnxxx	Value [ppm] In case of error this value will be set to 0.

Table 4: Telegram description of Elvaco Sense 300W

7 Troubleshooting

7.1 The Wireless M-Bus receiver does not receive any telegram from the sensor

Please verify that:

- The sensor has been activated.
- The receiver is connected to a power source and is correctly configured.
- The receiver is within range of the radio signal.
- The receiver antenna is mounted properly.
- The receiver and the sensor use the same wireless M-Bus mode (C1a).
- The sensor is not mounted inside a metallic cabinet.
- The sensor is not disturbed by other radio equipment.
- The sensor battery voltage is in operating condition. Use Elvaco OTC app (NFC) to verify.
- If the meter value does not show up in the Elvaco OTC App after a second scanning the sensor is not powered.

7.2 Temperature value is inaccurate

Although the data collected by the temperature sensor is accurate, an incorrect positioning of the product can sometimes result in unintended temperature variations. When mounting the sensor, please verify that:

- The sensor is not mounted near any heat and cold sources.
- The sensor is not mounted in direct sunlight.
- The sensor is not mounted in a spotlight beam.

8 Technical specifications

8.1 Characteristics

Type	Value	Unit	Comments
Mechanics			
Casing material	ABS UL94-V0	-	White
Protection class	IP20	-	
Dimensions	76.2x76.2x22.5	mm	
Weight	60	g	Excluding batteries
Mounting	Wall-mount	-	
Electrical			
Power supply	Lithium Battery	-	Removable
Battery type	ER14505	-	
Battery size	AA	-	
Operating voltage	3.6	V	
Environmental			
Operating temperature	0 – 50	°C	
Operating humidity	0 – 85	%RH	No condensation
Operating altitude	0-2000	m	
Pollution degree	Degree 2	-	
Usage environment	Indoor	-	
Storage temperature	-40 – 85	°C	
Sensor characteristics			
Temperature range	0 – 50	°C	
Temperature accuracy	± 0.2	°C	
Humidity range	0 - 85	%RH	
Humidity accuracy	± 2	%RH	
CO ₂ range	400 – 10 000	ppm	
CO ₂ accuracy	± 30	ppm	At 400-5000 ppm, ± 3% of reading (15-35 °C, 0-80% RH)
CO ₂ accuracy	± 10	ppm	At 5001-10000 ppm, ± 10% of reading (15-35 °C, 0-80% RH)
User interface			
LED	Activation	-	
App support	Elvaco OTC	-	Using NFC
Wireless M-Bus			
Frequency	868.95	MHz	
Transmit power	25	MW	
Transmit interval	According to Table 6	min	
Encryption	Yes/No	-	Mode 5 or 0

Wireless M-Bus modes	C1a/C1b/T1	-	C1a (default)
Wireless M-Bus Standard	EN13757:2018	-	
OMS Standard	4.0	-	

Table 5: Technical specifications

8.2 Factory default settings

Sensor	Function	Value
Elvaco Sense 100W	Transmit interval	3 min
Elvaco Sense 200W	Transmit interval	6 min
Elvaco Sense 300W	Transmit interval	15 min
Elvaco Sense 300W	Automatic Baseline Calibration	On
Elvaco Sense series	Wireless M-Bus mode	C1a
Elvaco Sense series	Encryption mode	Off
Elvaco Sense series	Setup lock	No

Table 6: Factory default settings

8.3 Dimensions (mm)

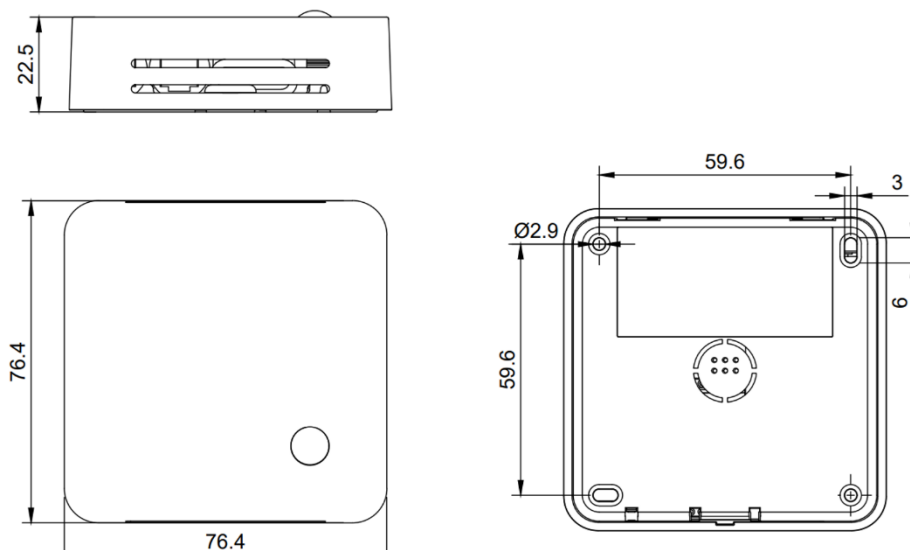

Figure 4 Dimensions

9 Type approvals

The Elvaco Sense series is designed to comply with the directives and standards listed below.

Approval	Description
EMC	2014/30/EU
RED	2014/53/EU
LVD	2014/35/EU
REACH	2011/65/EU + 2015/863

Table 7: Type approvals

10 Document history

10.1 Versions

Version	Date	Description	Author
1.0	2023-11	Initial version	Nikki Sjölander